



# Quick Installation Guide

## X3-Retro Fit 8kW-10kW

### II

### Mounting Steps

1 - Mark position of five holes.

2 - Drill holes with  $\phi 10$  drill. - Depth: at least 60mm.

3 - Tighten the expansion tubes.

4 - Screw the expansion screws.

5 - Match the inverter with the bracket. - Buckle the back card of the inverter back to the back of the wall.

### I

### Packing List

### III

### AC Connection

AC connection steps(AC cable size: refer to table1):

1.Remove the top-down cover. ( $\phi 4$  hexagon wrench.torque: $3 \pm 0.1\text{Nm}$ )

2. Make AC wires.

3. Insert AC cable into AC port through screw cap.

4. Connect the wire to the AC terminal in the inverter.

a. L-wire,N-wire connection (The screwdriver .torque: $1.2 \pm 0.1\text{Nm}$ )

b. PE wire connection (The sleeve .torque: $1.2 \pm 0.1\text{Nm}$ )

Model	X3-Fit-8.0-E	X3-Fit-8.0-C	X3-Fit-10.0-E	X3-Fit-10.0-C
Cable	4-5mm	4-5mm	5-6mm	5-6mm
Micro-breaker	32A	32A	32A	32A

table1

### IV

### EPS Connection(for E Version )

EPS wiring diagram

- E Version • For AU/NZ
- E Version • For Other Countries

The cable is not required for Australia

Changeover device with interlocked switching

DPDT

This function can be achieved manually or automatically according to user's preference. For manual solution, please install an external switch.

EPS connection steps:

1. Make wire(eps cable size: refer to table 2)

For Australia/New Zealand

For other countries

Model	X3-Fit-8.0-E	X3-Fit-8.0-C	X3-Fit-10.0-E	X3-Fit-10.0-C
EPS Cable	5mm	5mm	5mm	5mm
EPS breaker	32A	32A	32A	32A

table2: Cable and Micro-breaker recommended

2. Insert EPS cable into EPS port through screw cap. (One-word screwdriver.torque: $1.2 \pm 0.1\text{Nm}$ )

Australia/New Zealand

other countries

Note: The right most port should not be connected!

Note: Connect PE wire into PE port at right side!

### V

### Battery Connection(optional)

Battery connection diagram

Battery breaker

Before connecting to battery, please install a nonpolarized DC breaker to make sure inverter can be securely disconnected during maintenance.

Model	X3-Fit-8.0-E	X3-Fit-8.0-C	X3-Fit-10.0-E	X3-Fit-10.0-C
Voltage	Nominal voltage of DC breaker should be larger than maximum voltage of battery.			
Current[A]	50A			

BMS PIN Definition

Communication interface between inverter and battery is CAN with a RJ45 connector.

PIN	1	2	3	4	5	6	7	8
Definition	NTC	GND	GND	BMS_CANH	BMS_CANL	GND	BMS_485A	BMS_485B

Note: The battery communication can only work when the battery BMS is compatible with the inverter.

A:Power Connection Steps:

Press down spring until it clicks audibly into place

(tighten torque: $3.0\text{Nm}$ )

wire strands

The fine wire strands must be seen in the chamfer

(tighten torque: $3.0\text{Nm}$ )

(tighten torque: $3.0\text{Nm}$ )

B:Communication Connection Steps:

Step1: Disassemble the BMS cable gland.

Step2: Prepare a communication cable(without sheath)and insert the communication cable through the cable nut.

Step3: Assemble the cable gland and screw the cable nut.

## Meter connection diagram

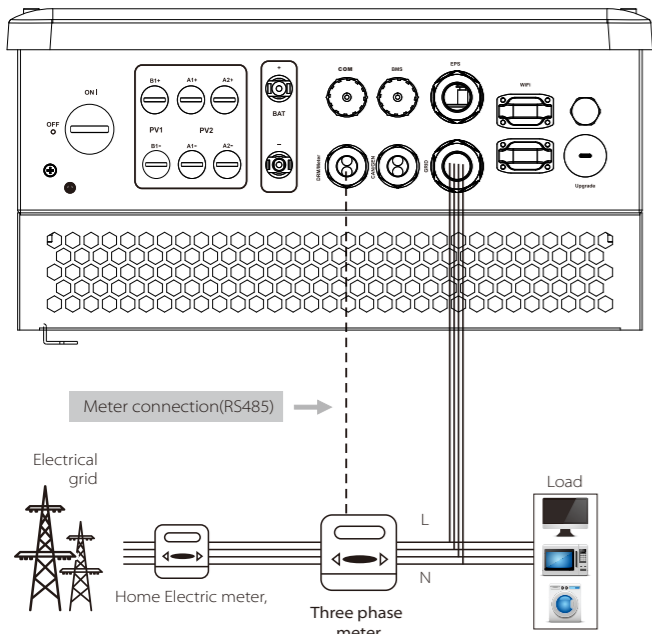

Communication interface between inverter and meter is RS485 with a Green terminal.

## Meter connection step

1) Insert L/N wires and the 485 cable into the meter.

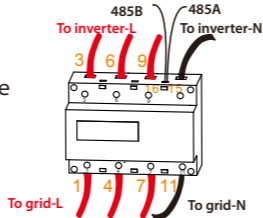

2) Insert the other side of the cable into the meter port on the inverter.

a. Unscrew the cable nut of Meter connector and insert two communication wires through it.

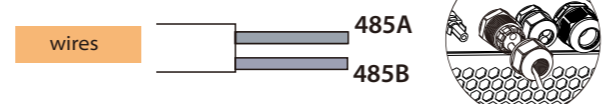

b. Trip the insulation from the communication cable, and then insert it into connector. (Torque:  $0.2 \pm 0.1 \text{ Nm}$ )

c. Insert connection into corresponding Meter terminal inside of the inverter. (Torque:  $0.4 \pm 0.1 \text{ Nm}$ )

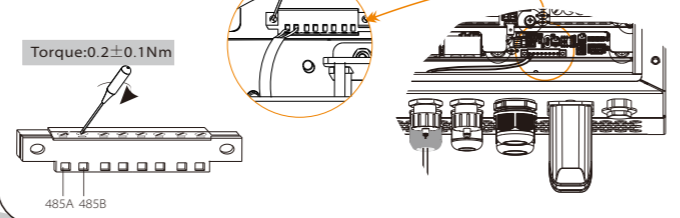

## Firmware Upgrading

## Preparation

Please ensure the inverter is steadily powered on. Inverter must keep the battery on through whole procedure of upgrading. Please prepare a PC and an U-disk.

**Warning!** Make sure the battery voltage is more than 180V, otherwise it may result in serious failing during upgrading.

1) Please contact our service support to get the update files, and extract it into your U-disk as following:

"update\ARM\618.00098.00\_Hybrid\_X3G3\_Manager\_VX.XX.XX.XX.usb";  
"update\DSP\618.00096.00\_Hybrid\_G3X3\_Master\_VX.XX.XX.XX.hex";

2) Press the "Enter" key for 5 seconds to enter Off Mode. Then unscrew the waterproof lid and insert U-disk into the "upgrade" port at the bottom of the inverter.

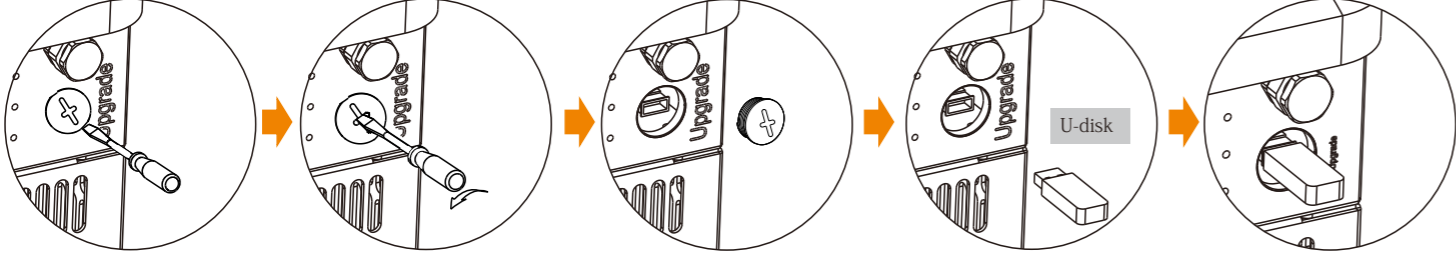

3) The LCD will be shown as the picture. Then press up and down to select the one that you want to upgrade and press "OK" to confirm to upgrade.

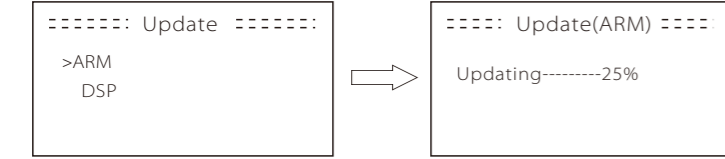

4) After the upgrade is finished, the LCD will display "succeed"(only for DSP upgrades), please remember to pull off the U-disk, screw the waterproof lid and press the "Esc" to return to the Main interface. Then press the "Enter" key to exit Off Mode.

## Earth Connection Steps(mandatory):

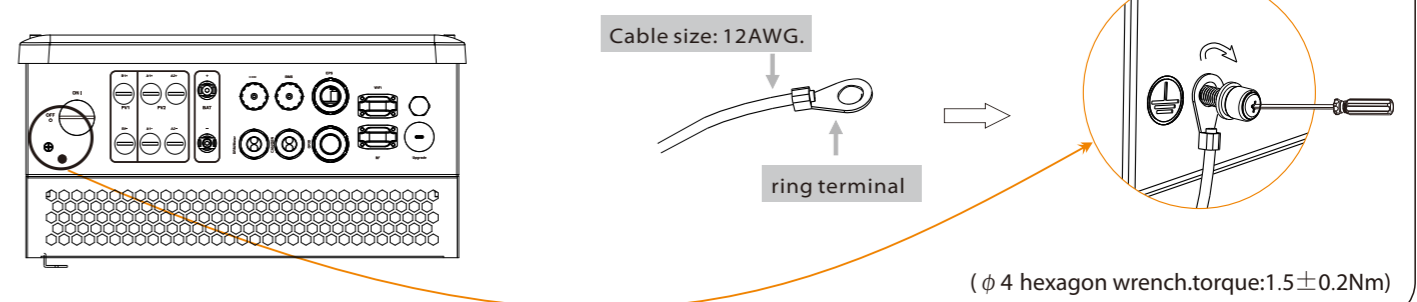

## Start inverter

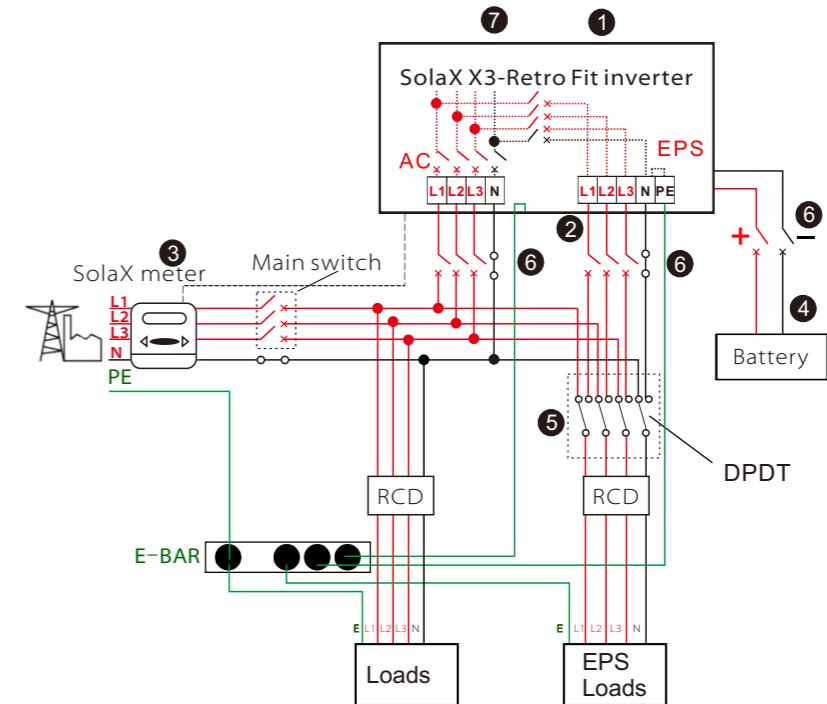

- 1 Ensure the inverter fixed well on the wall.
- 2 Make sure all the AC wirings are completed.
- 3 Make sure the meter is connected well.
- 4 Make sure the battery is connected well.
- 5 Make sure the external EPS contactor is connected well. (if needed)
- 6 Turn on the AC switch, EPS switch and battery switch.
- 7 Press the "Enter" key for five seconds to exit Off Mode. (The mode is factory defaulted as Off Mode)

Inverter will start up automatically when the battery is discharging. Check the status of indicators and LCD screen. The left indicator should be blue and the indicator screen should display the main interface.

## Start Guide

## 1.Set language

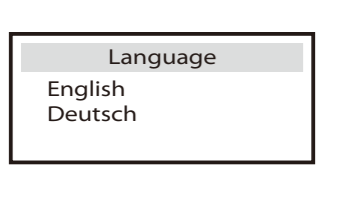

## 2.Set date time

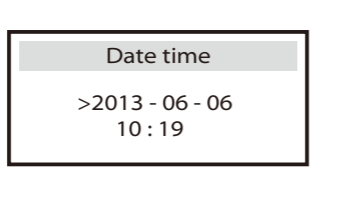

## 3.Set the safety standard

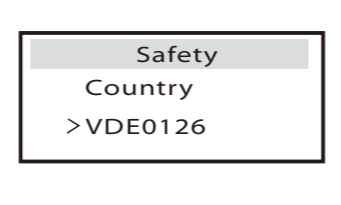

## 4.Set export control

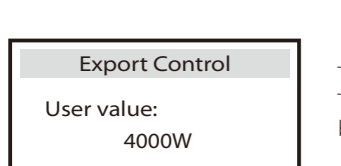

This function allows the inverter able to control energy exported to the grid. There are user value and factory value. The factory value is default which can not be changed by user. The user value setting by installer must be less than the factory value.

## 5.Set work mode

There are 4 work modes for choice.  
Self use/  
Back up mode/  
Feed in Priority/  
Force Time Use

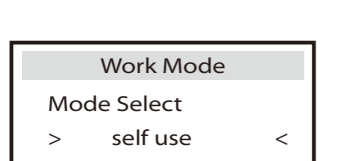

Parameter	Comment
Self Use (default)	The external generator generated power will be used to supply the local loads firstly, then to charge the battery. The redundant power will export to the public grid.
Back Up Mode	When there is no external generator supplied, battery will discharge for local loads firstly, and grid will supply power when the battery capacity is not enough. Battery will stop discharging to keep higher capacity when the grid is on. Only when the grid is off and PV energy is not enough, battery will start to discharge to keep the emergency load working normally. This work mode applies to the area where suffering from blackout regularly.
Feed in Priority	The priority of inverter output power is: supplying the load → feeding to the grid → charging the battery. This work mode applies to the area with high feed-in tariff.
Force Time Use	In this work mode the charging and discharging time can be set flexibly, and it also allows to select whether charge from the grid or not.

## 6.Set EPS system(For E Version only)

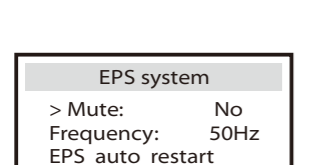

X3-Retro Fit inverter with E Version can work on the EPS mode. EPS parameters can be set as below.  
- "Mute" means you can set the warning of system which has entered EPS mode.  
- "No" means there will be a buzzing and it is the default value.  
- "Yes" means you choose to shut down the warning function.

Besides, if the buzzing is sharp, it means EPS output is over loads.  
Frequency \* here can be set 50Hz or 60Hz please based on correlative loads.

## Monitoring Operation

Solax provides two ways for users to choose: WiFi (optional) and RS485

## WiFi (optional)

Inverter provides a WiFi port which can collect data from inverter and transmit it to monitoring website via a Pocket WiFi. (Purchase the product from supplier if needed)

## Diagram

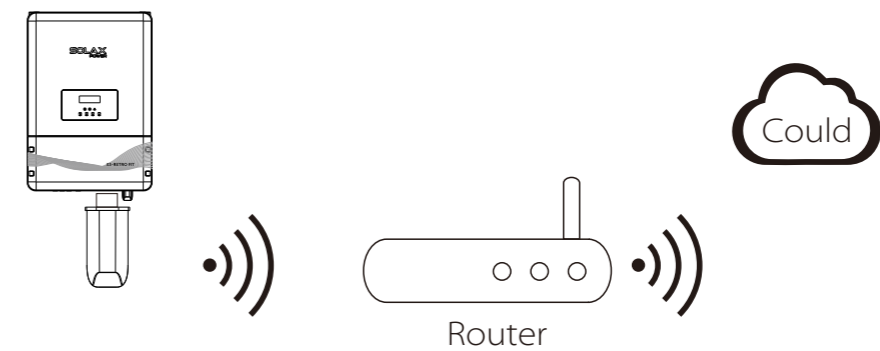

## WiFi Connection Steps:

Step 1. Plug Pocket WiFi into "WiFi" port at the bottom of the inverter.

Step 2. Build the connection between the inverter and router.

Step 3. Create an user account online. (Please check the Pocket WiFi user manual for more details.) (PH1 cross screwdriver .torque:  $1.5 \pm 0.1 \text{ Nm}$ )

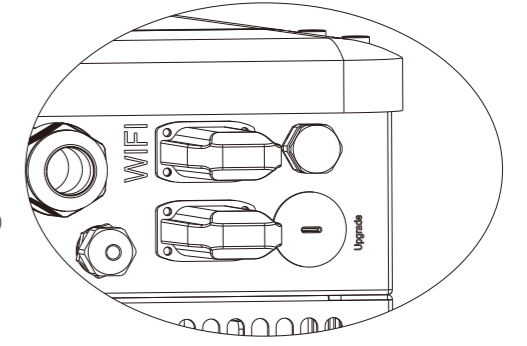

## COM

COM communication interface, which can be upgraded to man-machine communication interface. Output voltage, current, frequency, fault information and other operational information can be transferred to PC or other monitoring equipment through these interfaces.

## Application Occasion

COM is one standard communication interface which can transmit the real data from inverter to PC or other monitoring equipments.

## COM PIN Definition

Communication interface between inverter and router is RS485 with a RJ45 connector.

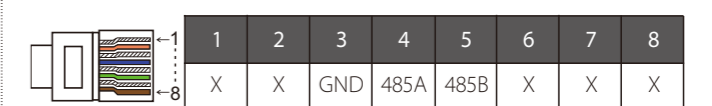
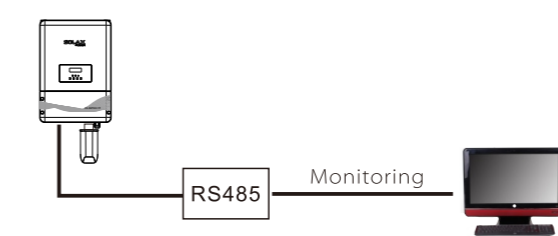

## COM Connection Steps:

Please refer to BMS connection steps (for user manual page 32) for COM connection. Please kindly noted the PIN definition and port position will be slightly different.

